

## AC/DC power supplies TESA250



### Features

- Class: Industrial, power density up to **793 W/dm<sup>3</sup>**
- Without Fan
- Low profile: 28 mm design with blade solder pins; terminal blocks (optional) or mounting on DIN-rail (optional)
- Case operating temperature ranges: -40°C...+85°C, -50°C...+85°C
- Output current up to 40 A, output power 250 W; one, two or three output channels
- Input voltage ranges: 100...242 VAC, 176...242 VAC
- Power factor correction
- Galvanic isolated output channels
- Over current, short circuit, overvoltage and thermal protection
- Output voltage adjustment
- Max capacitance 70000 µF (for U<sub>out</sub>=12 VDC, 50% Output power)
- Metal case

### Description

**AC/DC power supplies (modules) TESA250** are especially designed for industrial applications and harsh environment operation. This compact unit (134 x 84 x 28 mm) proven maximum output power of up to 250 W and it is available in versions with one, two, three or four **galvanic isolated** channels. The units have a full protection complex against over current, short circuit and overheating; they also can be connected in parallel or in series and provide compliance to EMC standard EN55022, class A (class B with filtration and protection modules TEFA5).

**TESA250-SxN, TESA250-SxP** is part of "Industrial" line of products designed for a variety of industrial equipments and made of customized element base. They are sealed with heat-conducting potting material and could have wide operating temperature range up to -50°C...+85°C also these modules have thermal protection chip. These power supplies undergo special temperature and burn-in tests with extreme on/off modes.

Upon customers' request this module can be produced in copper case with protecting coating, allowing its installation on aluminum heat sink and providing a positive effect on the modules EMC and heat transfer.

## Ordering information

### TESA 250 - 230W S 15 - S H N D

1      2      3      4      5      6      7      8      9

- 1 - «TESA» Series
- 2 - Max output power, W
- 3 - Input voltages
  - 230W** – 230 VAC (100...242 VAC)
  - 230** – 230 VAC (176...242 VAC)
- 4 - Index of output channels quantity
  - S** – one
  - D** – two
  - T** – three
- 5 - Nominal output voltage, VDC (two signs for a channel)
- 6 - Index of design option
  - S** - modification with polymer potting protection
- 7 - Index of case design and outputs
  - H** - case with a cover and blade solder pins (basic version)
  - C** - case with a cover and terminal blocks
- 8 - Index of operating temperature range of the case
  - N** -40°C ...+85°C (basic version)
  - P** -50°C ...+85°C
- 9 - Index of mounting on DIN-rail
  - D** – with clip for mounting on DIN-rail

## Technical information

### Standard models with one output

Module	Input voltage range	Output power	Output voltage / nominal output current	Typical efficiency
<b>TESA250-230WS05-XXX</b>	~100...242 VAC*	200 W	5 VDC / 40 A	80%
<b>TESA250-230WS12-XXX</b>	~100...242 VAC*	250 W	12 VDC / 20,8 A	82%
<b>TESA250-230WS15-XXX</b>	~100...242 VAC*	250 W	15 VDC / 16,7 A	82%
<b>TESA250-230WS24-XXX</b>	~100...242 VAC*	250 W	24 VDC / 10,4 A	84%
<b>TESA250-230WS27-XXX</b>	~100...242 VAC*	250 W	27 VDC / 9,26 A	84%
<b>TESA250-230WS48-XXX</b>	~100...242 VAC*	250 W	48 VDC / 5,21 A	86%
<b>TESA250-230S05-XXX</b>	~176...242 VAC	200 W	5 VDC / 40 A	80%
<b>TESA250-230S12-XXX</b>	~176...242 VAC	250 W	12 VDC / 20,8 A	82%
<b>TESA250-230S15-XXX</b>	~176...242 VAC	250 W	15 VDC / 16,7 A	82%
<b>TESA250-230S24-XXX</b>	~176...242 VAC	250 W	24 VDC / 10,4 A	84%
<b>TESA250-230S27-XXX</b>	~176...242 VAC	250 W	27 VDC / 9,26 A	84%
<b>TESA250-230S48-XXX</b>	~176...242 VAC	250 W	48 VDC / 5,21 A	86%

Modules with non-standard output voltage from 5 to 60 VDC with maximal output current up to 40 A, could be delivered on request.

\* For input voltage 230W (wide input) maximal output power decrease at input voltage 100...176 VAC according to the derating curves.

## Standard models with two outputs

Module	Input voltage range	Output power	Output voltage / nominal output current	Typical efficiency
<b>TESA250-230WD0505-XXX</b>	~100...242 VAC*	200 W	5 VDC / 20 A ; 5 VDC / 20 A	79%
<b>TESA250-230WD0512-XXX</b>	~100...242 VAC*	200 W	5 VDC / 20 A ; 12 VDC / 8,33 A	80%
<b>TESA250-230WD1212-XXX</b>	~100...242 VAC*	250 W	12 VDC / 10,4 A ; 12 VDC / 10,4 A	81%
<b>TESA250-230WD1515-XXX</b>	~100...242 VAC*	250 W	15 VDC / 8,33 A ; 15 VDC / 8,33 A	81%
<b>TESA250-230WD2727-XXX</b>	~100...242 VAC*	250 W	27 VDC / 4,6 A ; 27 VDC / 4,6 A	83%
<b>TESA250-230D0505-XXX</b>	~176...242 VAC	200 W	5 VDC / 20 A ; 5 VDC / 20 A	79%
<b>TESA250-230D0512-XXX</b>	~176...242 VAC	200 W	5 VDC / 25 A ; 12 VDC / 10,4 A	80%
<b>TESA250-230D1212-XXX</b>	~176...242 VAC	250 W	12 VDC / 10,4 A ; 12 VDC / 10,4 A	81%
<b>TESA250-230D1515-XXX</b>	~176...242 VAC	250 W	15 VDC / 8,33 A ; 15 VDC / 8,33 A	81%
<b>TESA250-230D2727-XXX</b>	~176...242 VAC	250 W	27 VDC / 4,6 A ; 27 VDC / 4,6 A	83%

Modules with non-standard output voltage from 5 to 60 VDC with maximal output current up to 40 A, could be delivered on request.

\* For input voltage 230W (wide input) maximal output power decrease at input voltage 100...176 VAC according to the derating curves.

## Standard models with three outputs

Module	Input voltage range	Output power	Output voltage / nominal output current	Typical efficiency
<b>TESA250-230WT051212-XXX</b>	~100...242 VAC*	200 W	5 VDC / 20 A ; 12 VDC / 4,2 A ; 12 VDC / 4,2 A	79%
<b>TESA250-230WT051515-XXX</b>	~100...242 VAC*	200 W	5 VDC / 20 A ; 15 VDC / 3,3 A ; 15 VDC / 3,3 A	79%
<b>TESA250-230T051212-XXX</b>	~176...242 VAC	200 W	5 VDC / 20 A ; 12 VDC / 4,2 A ; 12 VDC / 4,2 A	79%
<b>TESA250-230T051515-XXX</b>	~176...242 VAC	200 W	5 VDC / 20 A ; 15 VDC / 3,3 A ; 15 VDC / 3,3 A	79%

Modules with non-standard output voltage from 5 to 60 VDC with maximal output current up to 40 A, could be delivered on request.

\* For input voltage 230W (wide input) maximal output power decrease at input voltage 100...176 VAC according to the derating curves.

<b>Input specifications</b>	
Input voltage range / Input voltage transient deviation (1 s) 230 W**	~ 100...242 VAC (accepted=140...342V)/ ~ 100...264 VAC (accepted=140...373V)
Input voltage range / Input voltage transient deviation (1 s) 230	~ 176...242 VAC (accepted=248...342V)/ ~ 176...264 VAC (accepted=248...373V)
Input frequency	47...440 Hz
<b>Output specifications</b>	
Instability of output voltage in accordance to changing of output current from 10 to 100% for single output model	±2%
Instability of output voltage in accordance to changing of output current from 10 to 100% for dual, triple and four output model	±2% for chan.1, ±7% for chan.2, 3
Instability of output voltage in accordance to changing of output current for dual, triple and four output model with a voltage value ≥20%	±2% for chan.1, ±12% for chan.2, 3
Instability of output voltage in accordance to instability of input voltage	±0,5%
Ripple and noise (peak-to-peak) (20 MHz)	<2% Uout
Short circuit protection***	>150% Iout nom, auto repair
Overvoltage protection***	<150% Uout
Over current protection level***	Pout ... 1.3·Pout
Remote On/Off (inverse control – optional)	Shuts down outputs by applying 3...5 VDC (≤5mA) on "+REM", "-REM"
The maximum output power without the heatsink, Tamb=50°C	52 W
Max capacitance for Uout=12 VDC, 50% Output power	70000 µF****
<b>General specifications</b>	
Case temperature (operating N)	-40°C...+85°C*****
Case temperature (operating P)	-50°C ...+85°C*****
Case temperature (storage)	-50°C ...+85°C
Output power derating (natural convection)	See diagram (dashed, dash-dotted curves)
Output power with heatsink	See diagram (solid curve)
High humidity	95% @ 35 °C
Conversion frequency, fixed	200 kHz typ.
Insulation voltage input/case	~1500 VAC
Insulation voltage input/output	~3000 VAC
Insulation voltage output/case	~500 VAC
Insulation voltage output/output	=500 VDC
Isolation resistance @ 500 VDC	20 MOhm
EMC standards	EN55022, class A (class B with filter TEFA5)
Safety standard	IEC/EN60950
Thermal resistance case — environment without heat sink	2,7 °C/W
Typical MTBF (Tcase = 50°C; Pout = 0,7 Pout max)	40 000 hrs
Cooling method	Free air convection with heat sink or forced air
Weight (max)	600 g

\* All specifications are valid for normal climatic conditions, Uin.nom., Iout.nom., unless otherwise stated.

\*\* For input voltage 230W (wide input) maximal output power decrease at input voltage 100...176 VAC according to the derating curves.

\*\*\* Parameters are stated for the information purposes and could not be used at long term work, exciding maximum output current, at work outside of a range of working temperatures, at module's work with the output voltage over a range of adjustment.

\*\*\*\* For other output voltages the maximum output capacity is calculated from the fact that  $\frac{C_{max} \times U_{out}^2}{2}$  is a constant.

\*\*\*\*\* Turn-on delay of power supply at subzero temperatures can reach up to 5s at -40°C, 15...20s at -50°C.

## Output power vs an ambient temperature for 230, 230W Inputs

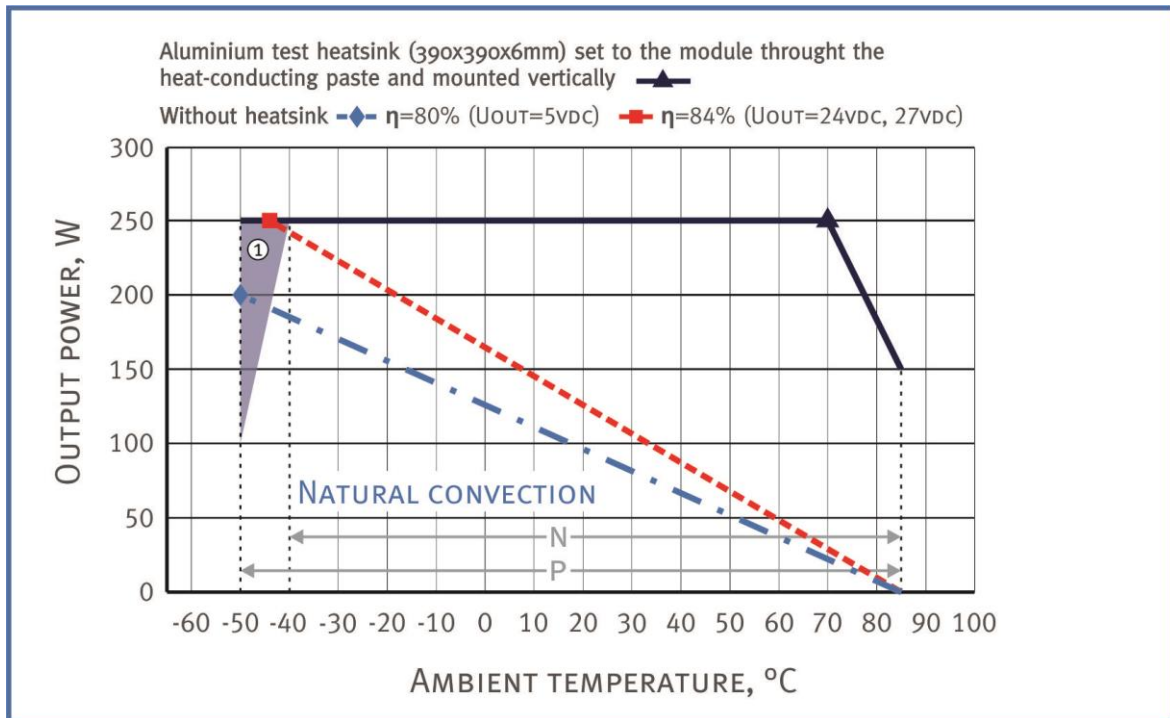

Dropping parts of the dashed and dash-dotted curves are in accordance with the **maximum temperature of the case** (for modules with index «N», «P» equal to +85 °C). Output power must not exceed the values which are limited by corresponding curve for a given ambient temperature.

Modules can be used without a heat sink only when screwing them heat conductive plate with thermal paste and with the length and width not less than case size and thickness of not less than 3 mm.

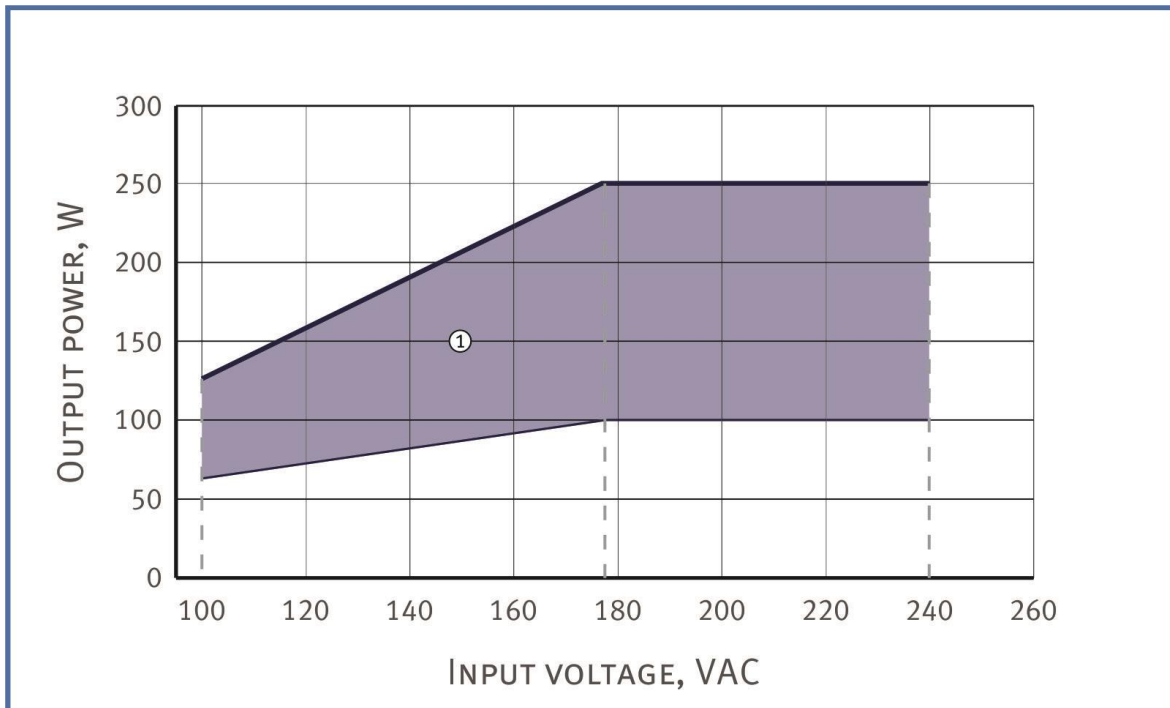

At point ▲, ◆ and ■ simultaneously present several extreme worst-case conditions, such as the combination of maximum case temperature and maximum output power. Continuous module operation at these points should be avoided.

## Output power vs input voltage (for models with input voltages 230, 230W)





① - For ambient temperature -50°C...-40°C in gray areas of diagrams some specification parameters may not be met.

### Pin out (models with blade solder pins)

Nº Pin	1	2	3	4	5	6	7	8	9	10	11	12	13
<b>Single output</b>		N	L	-REM	+REM	-OUT1	-OUT1	+OUT1	+OUT1	—	—	—	—
<b>Dual output</b>		N	L	-REM	+REM	-OUT1	+OUT1	-OUT2	+OUT2	—	—	—	—
<b>Triple output</b>		N	L	+REM	-REM	+OUT1	+OUT1	-OUT1	-OUT1	+OUT2	-OUT2	+OUT3	-OUT3

### Pin out (models with the terminal blocks)

Nº Pin	X1.1	X1.2	X1.3	X2.1	X2.2	X2.3	X2.4	X2.5	X2.6	X2.7	X2.8	X2.9	X2.10	X3.1	X3.2
<b>Single output</b>		N	L	-OUT1	+OUT 1	—	—	—	—	—	—	—	—	- REM	+ REM
<b>Dual output</b>		N	L	- OUT1	+OUT 1	-OUT 2	+OUT2	—	—	—	—	—	—	- REM	+ REM
<b>Triple output</b>		N	L	+ REM	- REM	+OUT 1	+OUT1	-OUT1	- OUT1	+OUT 2	-OUT 2	+OUT 3	-OUT 3	—	—

**Single output model with blade solder pins (III case size)**

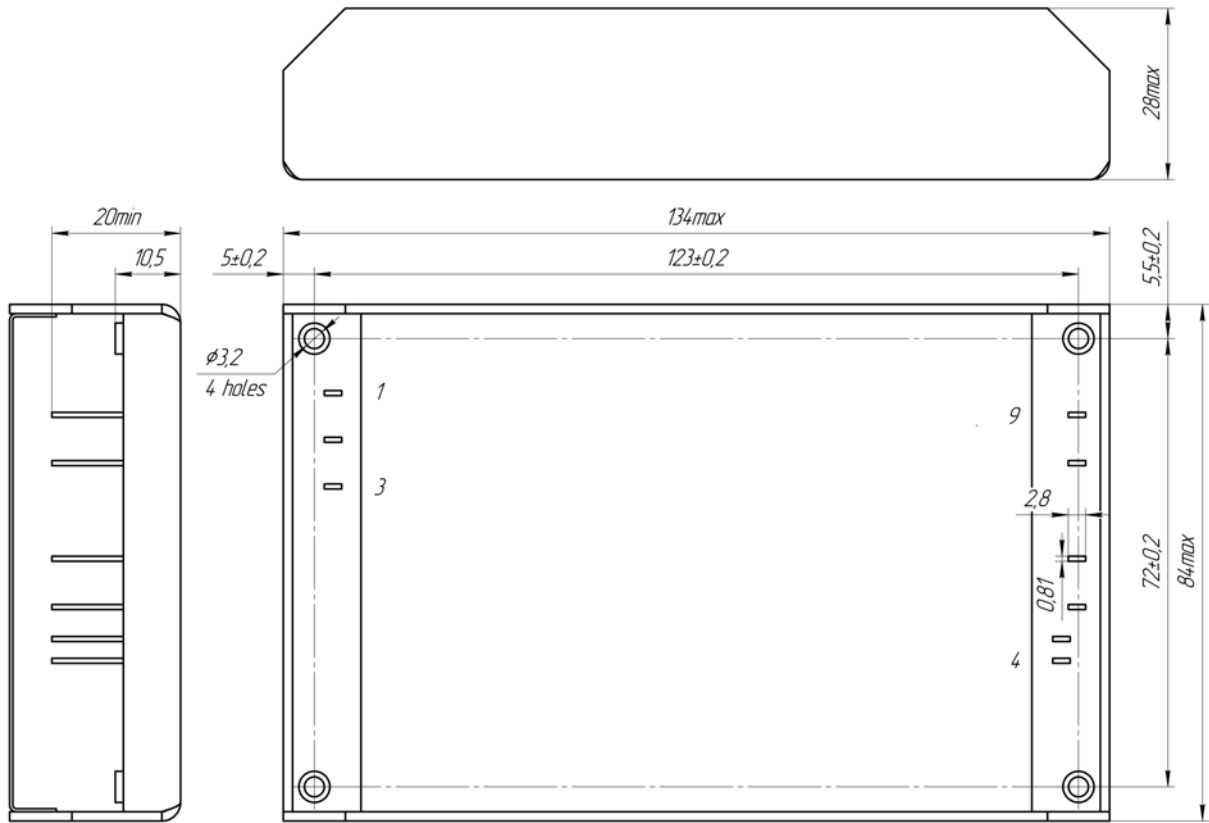

**Single output model with terminal blocks (III case size)**

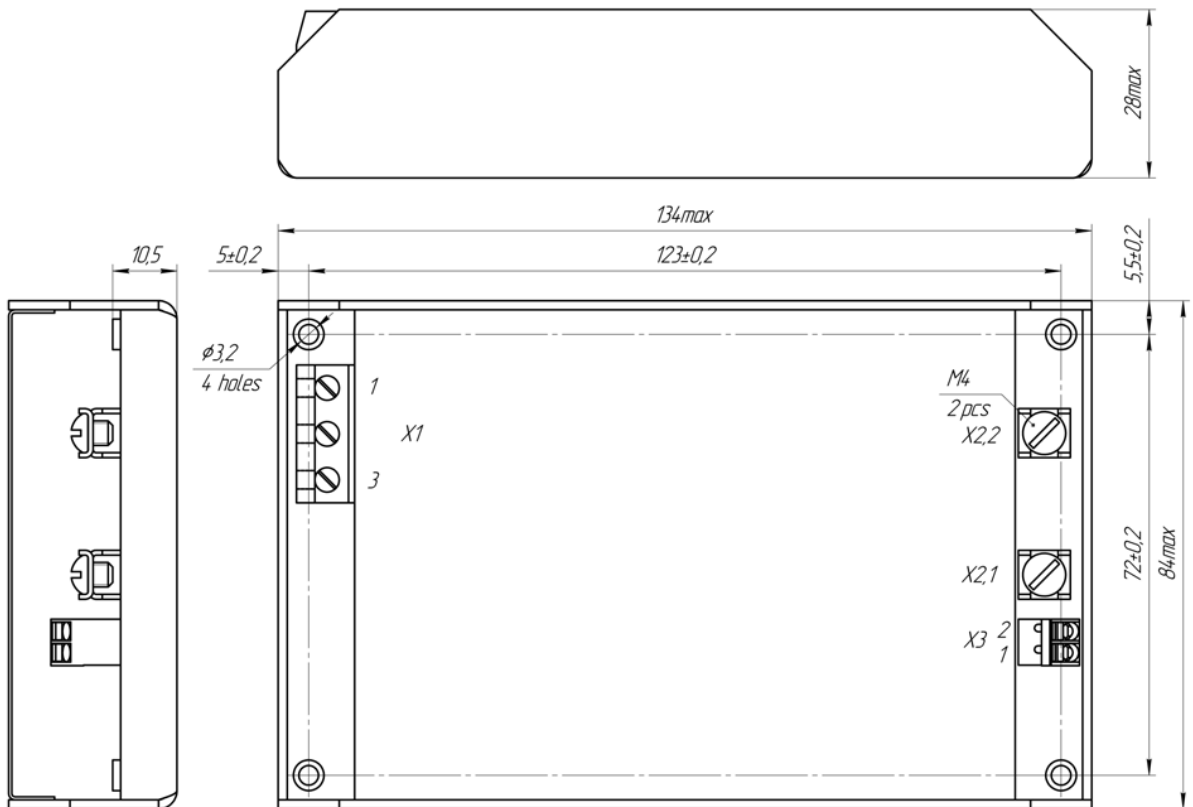

**Dual output with blade solder pins (III case size)**

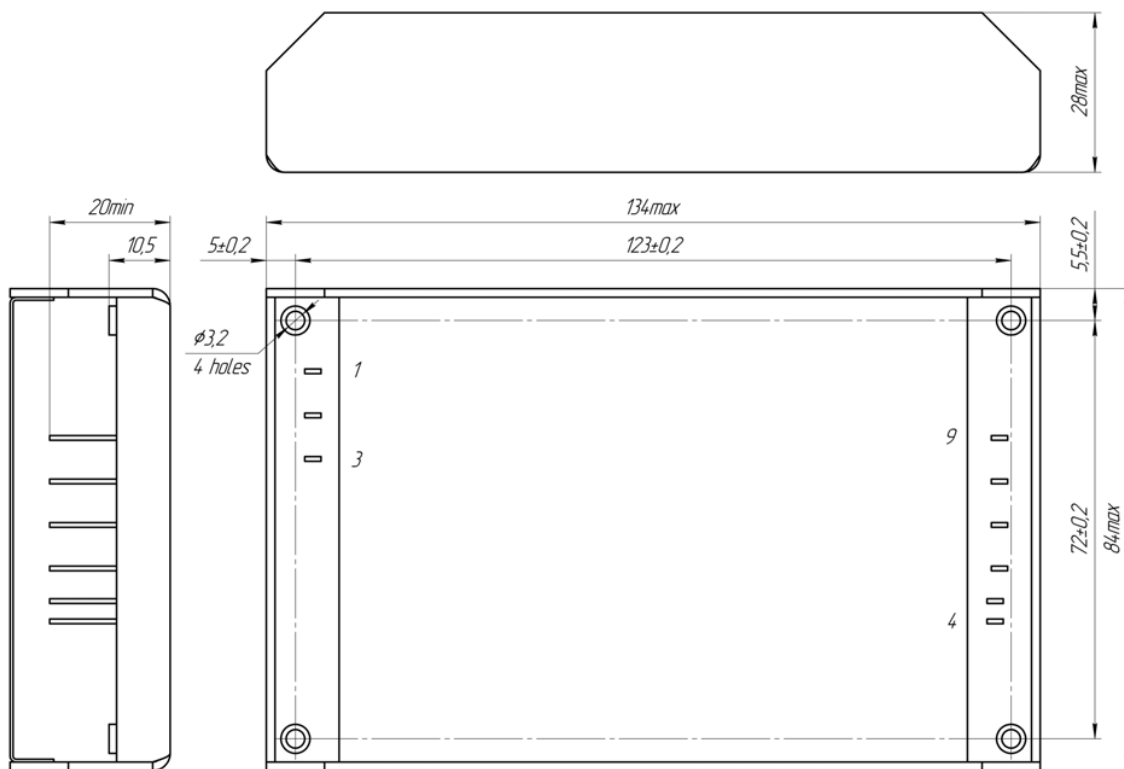

**Dual output with terminal blocks (III case size)**

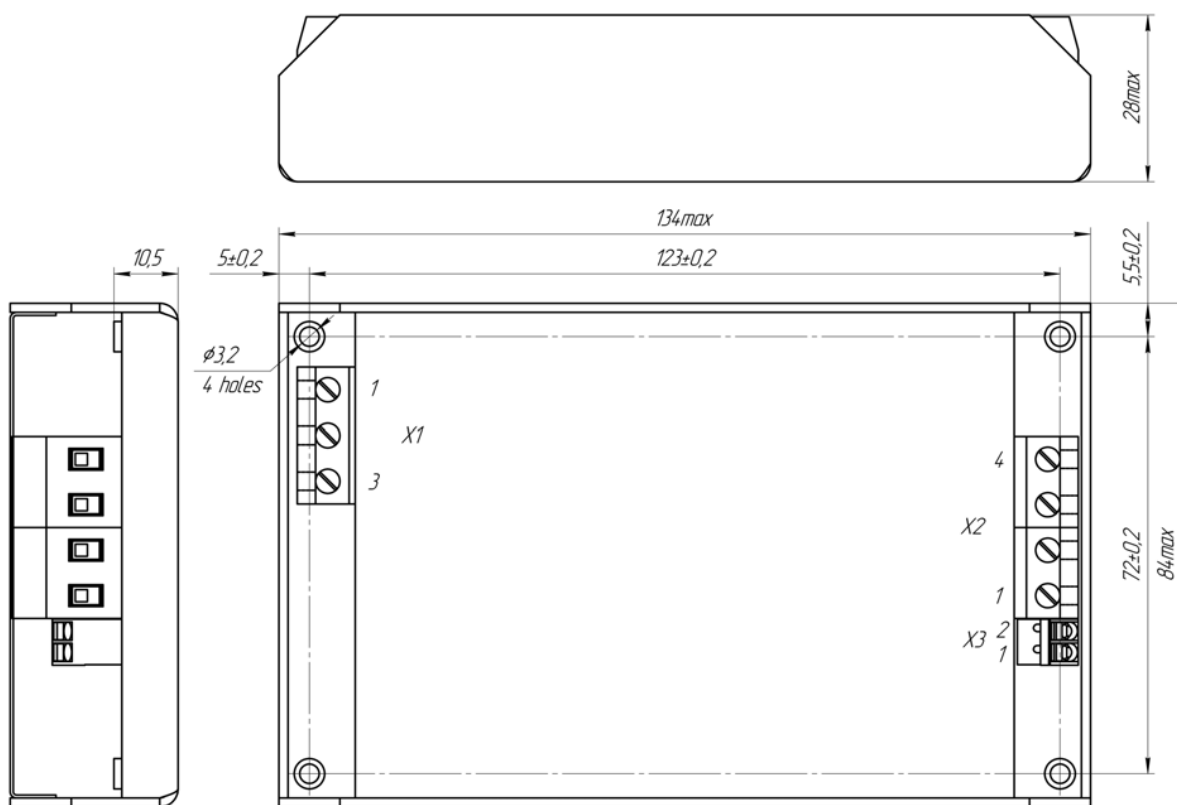



**Triple output model with blade solder pins (III case size)**

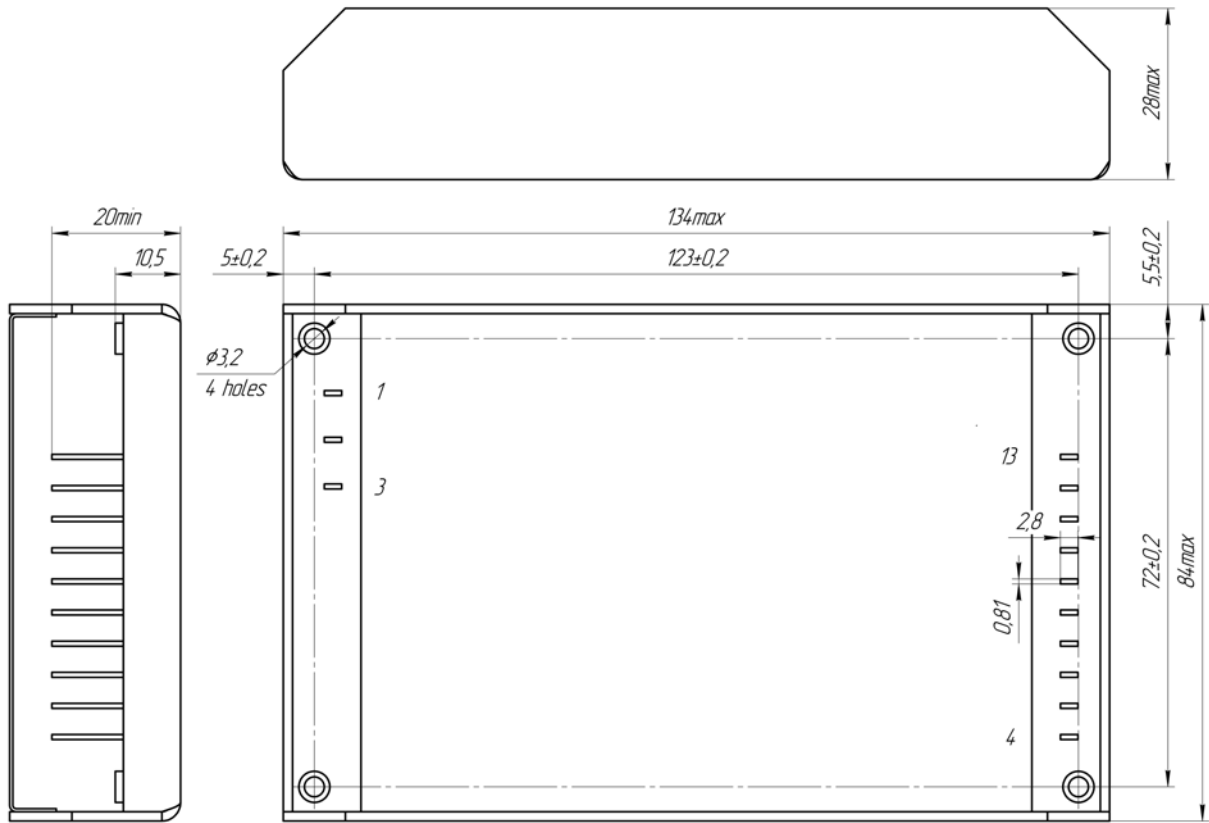

**Triple output with terminal blocks (III case size)**

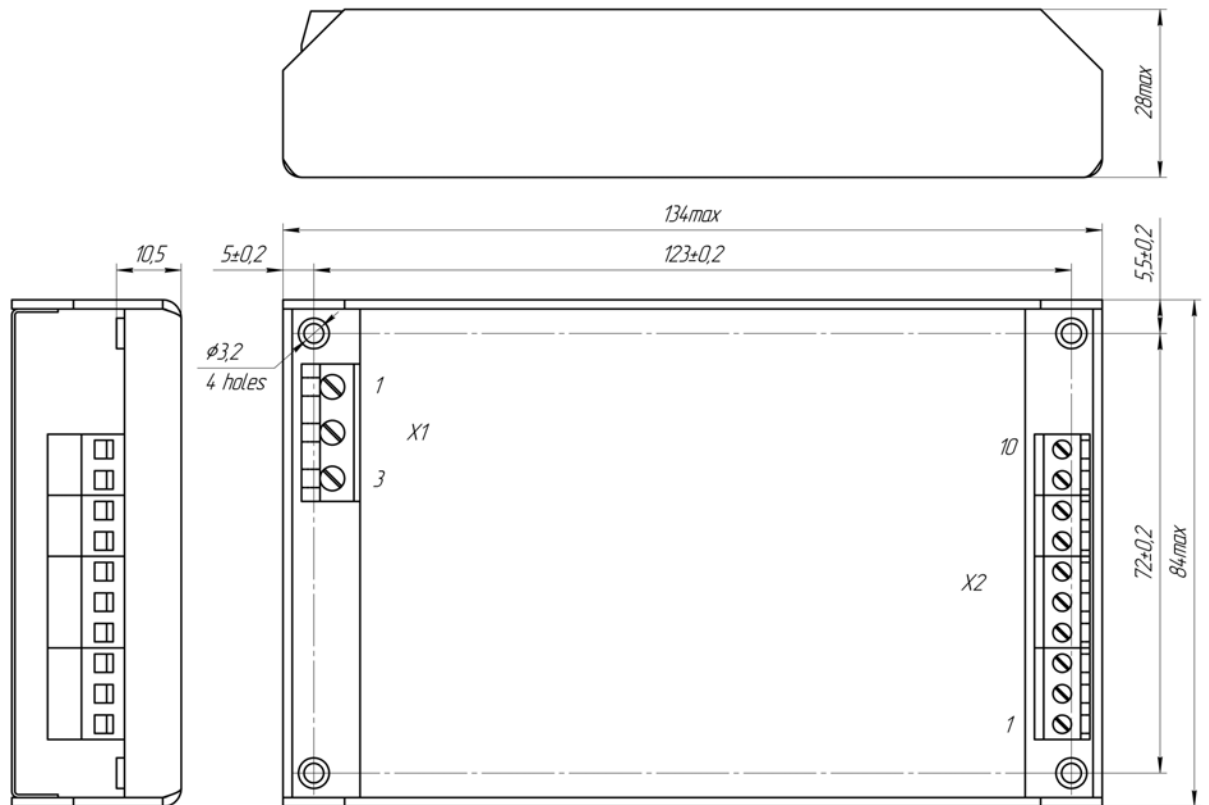

Case with a capability of DIN mounting (EN50022-35x15/7.5)

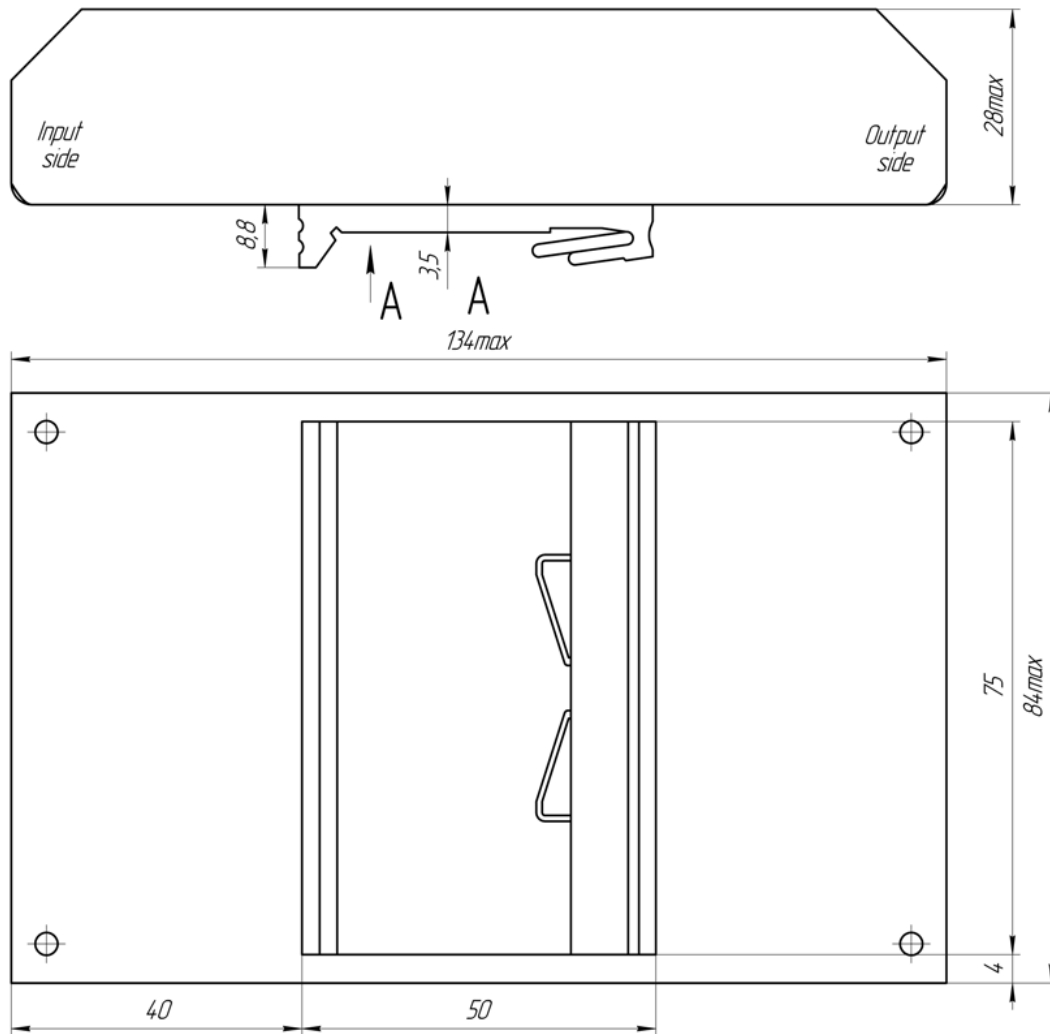

## Certificates

Certificate ISO 9001\*  
CE conformity declaration

\* Management system and R&D of Alexander Electric is ISO certified

## Note

The input, output and service pins connections of these power supplies are made through blade solder pins either by using standard female terminals or soldering.  
The module's connection to the equipment with screw terminals allows the possibility to organize fast installation and easy change of modules during tests or operation in equipments that are not influenced by vibration or aggressive environments.  
The module's connection to the equipment by soldering the blade solder pins of flexible wires ensures maximum reliability and minimum voltage drop under effect of adverse mechanical, climatic and chemical factors.  
Blade solder pins' modules do not require service of connections (commonly known as periodic tightening of screw terminals) during module's entire life time. This provides more convenience during operation and is a major advantage of these products.

Please, note that all information in this material is for reference only. Further detailed information (including: additional requirements, manuals and circuit schemes) is found on our website <http://www.aeps-group.ru>.

## Contact information

<http://www.aeps-group.ru>, e-mail: [aeps@aeps-group.cz](mailto:aeps@aeps-group.cz), phone/fax: +420 266 107 303

According to company's policy in view of constant improvements of the production design the manufacturer reserves the right to itself change the contents of promotional materials without prior notification.